

Review Article

The Study on Model of Variable and Motors Resistance on Series Circuit in the Stalled DC Motor

Xu Run^{1, 2*}, Zhiqiang Chen³¹Former Jhonsonelectric (HK) Co. Ltd, Sale and Technology Div. Shenzhen 518125, China²Gyeongsang National University, Material Engineering Dept, Jinchu, 52828, Korea³Jhonsonelectric (HK) Co. Ltd, Sale and Technology Div. Shenzhen 518125, China**Article History**

Received: 20.06.2021

Accepted: 28.07.2021

Published: 29.07.2021

Journal homepage:<https://www.easpublisher.com>**Quick Response Code**

Abstract: The stall phenomenon which happens in loaded motor is unqualification in application. Meanwhile it may measure the maximum property of DC (direct current) motor in manufacture. So the phenomenon is analyzed to find a simulation of electrical state to predict the maximum current and torque which is a necessary method to be proceeded up to now before design. We find that the simulation fits well to the reference. The conditions of $t=6s, R_2=25\Omega, U=20V$ result in the biggest stall force according to rotation to change time and voltage. Then it is $t=8s, R_2=20\Omega, U=16V$; $t=10s, R_2=15\Omega, U=12V$ and $t=12s, R_2=10\Omega, U=8V$ in turns. As for torque it is $t=6s, R_2=25\Omega, U=20V$; $t=8s, R_2=20\Omega, U=16V$; $t=6s, R_2=25\Omega, U=20V$ and $t=12s, R_2=10\Omega, U=8V$ in turns. With increasing resistance R_1 the power increases to 4W with 8V, and then to 6W, 7W, 10W with 12V, 16V, 20V respectively. With the increasing voltage and resistance R_2 and decreasing time the power will be bigger.

Keywords: Model, stalling; rotation, resistance, DC motor, multiple circuit.

Copyright © 2021 The Author(s): This is an open-access article distributed under the terms of the Creative Commons Attribution **4.0 International License (CC BY-NC 4.0)** which permits unrestricted use, distribution, and reproduction in any medium for non-commercial use provided the original author and source are credited.

1. INTRODUCTION

Motor slow rotation and stall is a severe quality issue in manufacture so it is needed that we shall pay more attention to it [1-4]. When the temperature is high, the free electrons collide big with the atoms that vibrate. In virtual welding, its resistance increases and the current decreases, so its rotation decreases at the same voltage. Variable clearance of rotor and bearing will cause periodic load fluctuation, which will cause voltage decrease, and the rotation will be slow or even stop. After using the motor for a period of time, the friction of the rotor causes fluctuation, so we need to pay attention to the motor wear under the action of load will also cause stall. In the machine tool if the long time rotation produces bearing wear need to replace it immediately in order to ensure the long time use of the rotating shaft. The above is the status of stall motor. So we regulate the resistance in order to change current for observing the stall torque. But it is found that the resistance can't cause big torque or stall torque due to its weakness. This is a conclusion from this study. But the rotation is available to present a certain torque even stall torque because they are high enough. This is a new finding in this paper. So it is thought that the further research will be proceeded on this resistance later. To

promote resistance and current is a way to approach the stall torque.

Controlling motor with multiple circuit resistance is important to measure the property in electricity. The test measure is complicate and difficult with wire and load. So if having a method to model its course is supposed the best one. In this study the multiple circuit resistance is adopted for measuring the rotation, power & torque of motor. To try to establish model to draw the curve between them and find variable value is our research destination. Once it is feasible the method will be adopted to evaluate the DC motor property in advance. In this paper to compare with actual value is to look for and find feasible parameters to map the gap between the model and practice. To regulate the resistance on multiple circuit will regulate the current which affects the motor load and property. So the resistance will play the role of regulating property in motor, which has an important role. In this study the deep research is done to simulate the circuit resistance for confirming the intrinsic relationship between them and look for method to search the effective factor to motor property with simulation.

2. MODELING AND DISCUSSION

According to energy w defining gains
 $dW = Fds$ (1)

Due to $\frac{dW}{ds} = F$ (2)

So $P = Fv$ (3)

Here F is force; s is distance.
 From electric power P and energy conservation law in terms of Figure 1 which is circuit simulation to estimate the stall status in parallel it gains, here R_1 is variable resistance; R_2 is motor resistance; R_{gen} is general resistance.

$P = IU = I^2 R_{gen}$ (4)

and $Pt = \frac{1}{2}mv^2$ (5)

Suppose $v = \frac{v_{shaft} d_1 k}{d_0}$ (6)

Here k is constant about 0.7~0.6; d_1 is armature diameter; d_0 is main shaft diameter; v_{shaft} is the out speed on armature .

From above two equations it gains the velocity

$v^2 = \frac{2Pt}{m}$ (7)

Replace (2) with (1) it gains

$dv = d\sqrt{\frac{2I^2 R_1 t}{m}}$ (8)

Here t is time; R is resistance; m is mass of rotor.

From equation (1) and (2) gains

$T = Fr$ and $F = \frac{P}{v}$ (9)

Due to velocity $v = r\omega$ (10)

Gains $v = \frac{\pi dn}{60}$ (11)

From (3), (9) and (10) gains the torque T of main shaft equation is

$dT = 9.55d\left(\frac{P}{n}\right)$ (12)

Replace above with (1) It gains the simplicity one as below

$dT = 9.55 \frac{I^2 dR_1}{n}$ (13)

Here n is rotation.

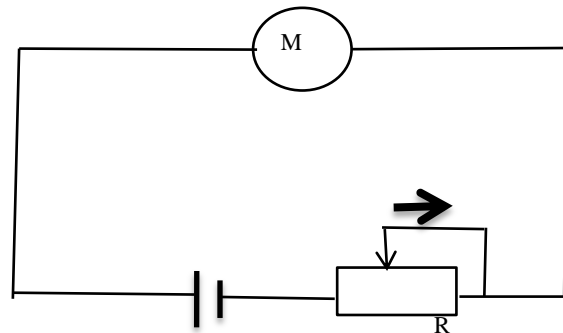

Figure 1: Circuit simulation under motor and variable resistance R

The motor armature mass is 27.9g and its diameter ϕ is 20mm in this study. The motor resistance is supposed 10 Ω , 15 Ω , 20 Ω , 25 Ω for each stage whilst the voltage is used 8V, 12V, 16V and 20V respectively. The maintaining time in variable resistance is 6s, 8.5s, 10s, 12s respectively.

3. DISCUSSIONS

In company the motor electrical property about the stall currency is proceeded by experiment method. If they are predicted the much save will be gained. So in this paper we build the equation modeling to analyze it with different conditions.

As shown in Figure 2 the result fits well with the reference practice. Two conditions are used to model the situation of practice which is stall time and voltage. Here the rotation is used to evaluate. Meantime the 6~12s(second) and 12~8V is adopted to do equation. It is observed that rotation is accession to 900rpm under $t=12s, R_2=10\Omega, U=8V$ and 1800rpm under $t=6s, R_2=25\Omega, U=20V$. At last 1800rpm is acquired under $t=8s, R_2=20\Omega, U=16V$. Moreover 950rpm is gained under $t=6s, R_2=25\Omega, U=20V$ at 400 Ω . The highest rotation happens in $t=8s, R_2=20\Omega, U=16V$ meantime the lowest one does in $t=12s, R_2=10\Omega, U=8V$. The highest is in $t=8s, R_2=20\Omega, U=16V$ which results in the lowest torque to resist stall. The curve will decrease steeply after 150 Ω , 200 Ω and 400 Ω . It expresses that the low rotation happens after these resistance. In Figure 2 with increasing resistance R_1 the power increases to 4W with 8V, and then to 6W, 7W, 10W with 12V, 16V, 20V respectively. With the increasing voltage and resistance R_2 and decreasing time the power will be bigger.

In the design or use to ensure that the voltage is large enough in motor. If the transformer is not used properly, the voltage will be reduced or even no voltage. These will cause the motor revolution to slow

down or even stop so we need to pay attention to their voltage changes. If the voltage goes up and the current goes up the motor burns out and it's dangerous so we have to be careful about whether the voltage goes up or down. The voltage in the circuit we designed should not be too small or the rated voltage of the motor should be consistent with the design voltage. If the two do not match, the motor will burn off or stop running, be sure to attract the attention of the relevant engineer. The transformer must be precisely adjusted before it can be used for measuring and using motors. When the PLC design is electrical components damage caused by short circuit will cause the voltage increased need to pay attention to Circuit design needs to protect the function of the motor, but also should be concerned about circuit short circuit and other voltage or current caused by excessive motor fault. Some circuit design is a functional role in order to make the motor to achieve the required a certain functions such as printer quickly followed suit, normal feed and fast return to demand, servo motor in the control of motor cycle with a certain load are prone to fatigue, leading to print qualities such as tilt up and down and not docking phenomenon. These are the side effects of motor dynamics after long-term use, belong to the motor life has reached the limit, out of service. If the equipment is new, replace the motor, but the factory needs to provide the motor. The motor that drives the plasma arc furnace in the laboratory to control the speed of the circular shaft also broke down during the cycle of use, which was also caused by excessive load. It means that the load beyond rate one will cause over heat to result current increasing over. It will release more heat to coil wire that makes the short circuit. The short circuit lets the current become big that produce open circuit to make circuit be open ie. failure. It has been exhibited when the machine works with abnormal condition like over load, over heat and long time. So in the factory there are many machine to use motor for working longtime and it will be dangerous to expose long time to work. The time will be not long for 8 hours and it shall have a rest after the time for ten minutes. So the motor can be rest and recovery it status which maybe cause a severe accident like making it be open circuit. The machine will stop

working to fix which can cause the economic damage if fix time is more than several days because it is too long.

Overview these are mechanical and electrical products under high voltage motor failure. So do not only seek accuracy and harm the load of this requirement, to strengthen the basic design of the motor, in the premise of ensuring the service life of the guarantee of precision. It is necessary to enhance the load and fatigue test of the motor sample, so as not to cause the shutdown within the specified period, tarnish the company's image and reduce the order quantity. The criteria manual has been complied with which may decrease the abnormal accident probabilities. For example oiling the machine and clear the mold will increase the motor lifespan which decreases the load efficiently. According to the model status is found and make scientific management. Often measuring the resistance will maintain the normal one. The resistance decreasing will increase the current and it may incline the accident probability. On the other hand the certain properties will be mastered from it. That is the new information for us to grasp in mind. So a certain one is good which knew from measurement and operation manual of machine motor. Frequently the measurement can be made the more information will be caught by us too. For motor there is PLM (production life cycle management) for us to use, so the whole situation may be grasped by us. We must know the details to machine motor through measuring their current or resistance.

Upon them the method to normalize the machine motor has been gradually produced to combine the specification of them. In general the prediction has been feasible for us to manage the machine motor. If there is any problem the effective factor will be found by us in future. Because there are many machine in a factory so the clear situation to their motor is as possible as soon. The substitution and fix one must be known by out engineers and experts so that they will be improved once the failure is to happen soon. If so the regulation and preparation will be both proceeded for accident of failure with machine motor.

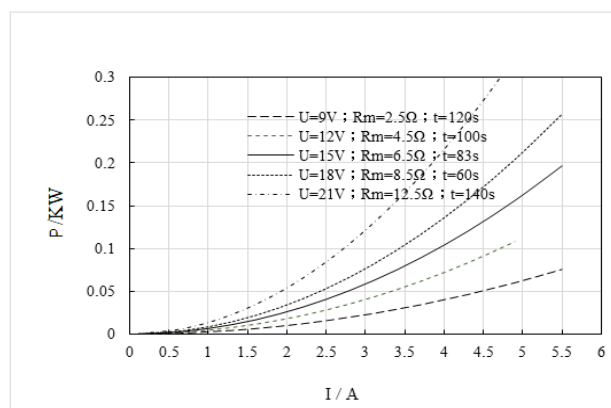

Figure 2: Relations of simulation power and current under different motor resistance R_m , t and U

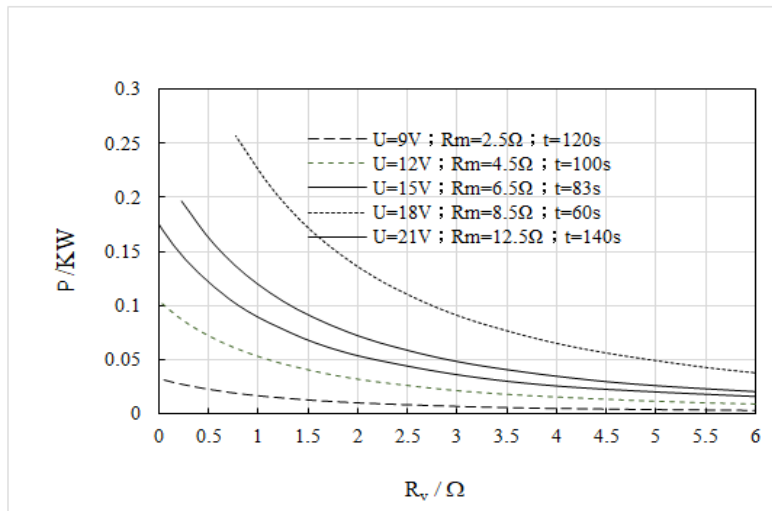

Figure 3: Relations of simulation power and resistance R_v under different motor resistance R_m , t and U

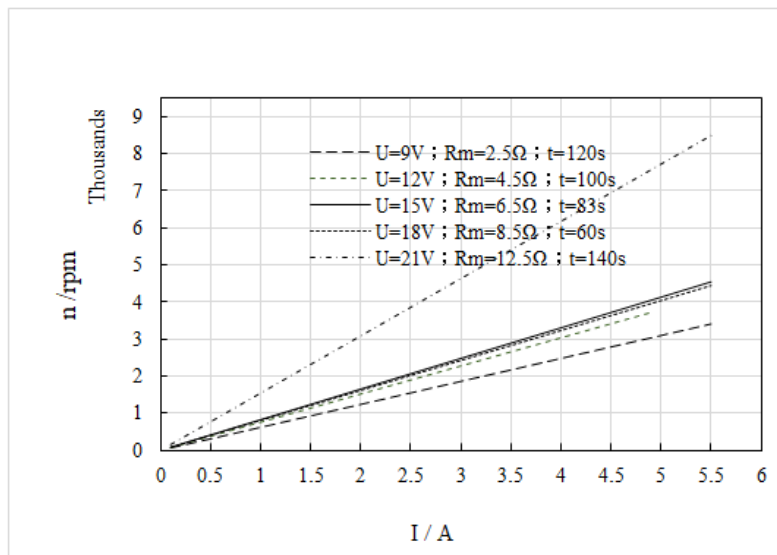

Figure 4: Relations of simulation rotation and current under different motor resistance R_m , t and U

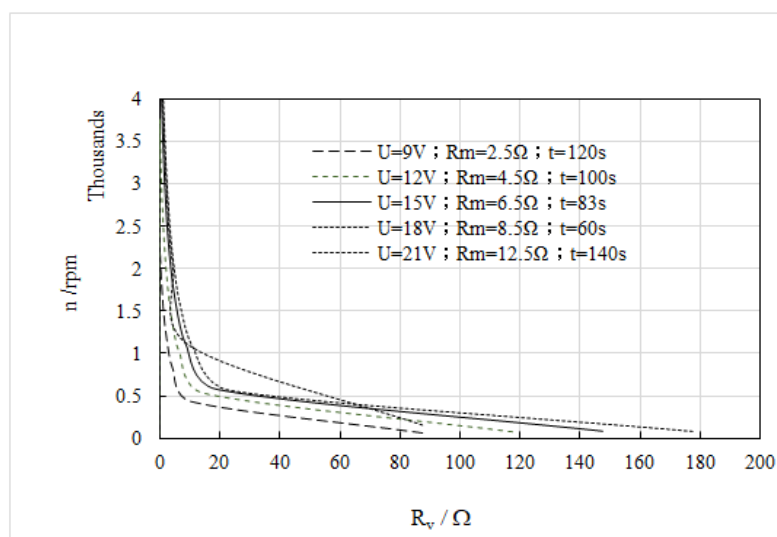

Figure 5: Relations of simulation rotation and resistance R_v under different motor resistance R_m , t and U

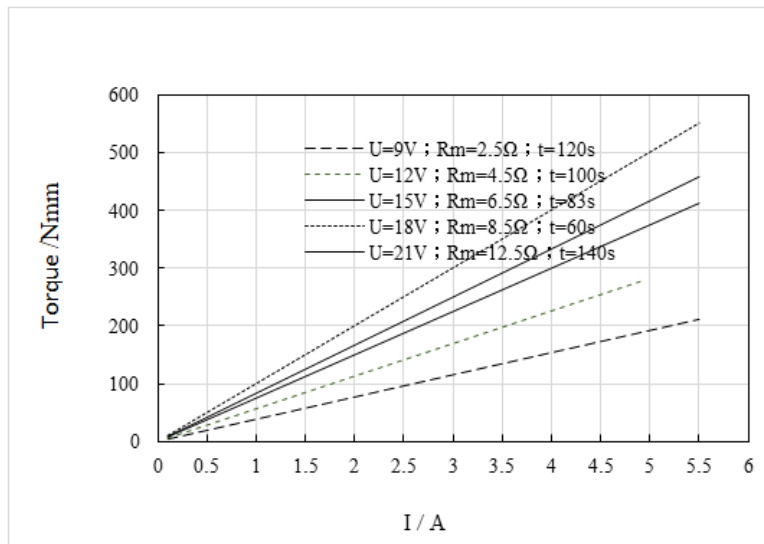

Figure 6: Relations of simulation torque and current under different motor resistance R_m , t and U

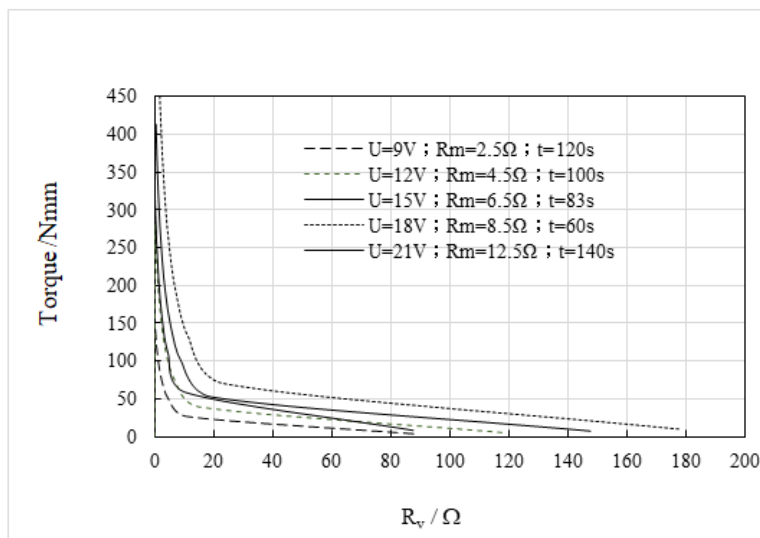

Figure 7: Relations of simulation torque and resistance R_v under different motor resistance R_m , t and U

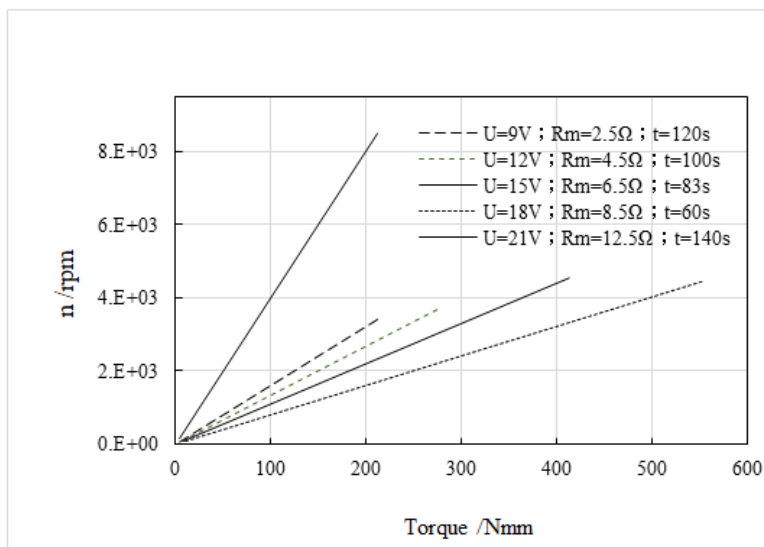

Figure 8: Relations of simulation torque and rotation under different motor resistance R_m , t and U

As shown in Figure 3 the torque will decrease with increasing resistance meantime it will become 4Nmm, 3Nmm, 2.5Nmm and 2Nmm under the different time and voltage of the above turn at 30Ω. At the t=12s and U=8V the torque will decrease at the utmost. Due to simulating stall it is limited by variable R value, so the rotation reflects this status optimum. According to rotation the resistant force is judged in this study.

As seen in Figure 4 the rotation of motor will incline when the resistance inclines. It is due to multiple circuit resistance which is in opposition to series connection. The steeper curve will be gained that means a little increasing resistance will cause rotation increasing rapidly. The voltage is the bigger the resistance will bigger too. Meantime the sluggish curve will be observed in this study. If the resistance in the motor becomes big the current will be small and the load be small. On the contrary if the one in a variable resistance becomes small the load will be small which may regulate the motor property. According to resistance in a motor or variable one the same effective will be obtained. Since the resistance in motor usually has been a constant one the regulation of variable resistance will can affect the voltage to change the current in the motor which has a regulation role. In this study the voltage is changed the resistance in a variable one has been related with property of them and through changing the one with different motor it is searched by the establishing the simulation. It is found that through the simulation curve the property in motor has been changed whilst it is found that they are non linear

curves. Moreover in Figure 4 it is found that with inclining the resistance to beyond 25Ω the different value will be obtained. The 16V is the biggest and then 15V, 20V, 25V turn is smaller.

4. CONCLUSIONS

The rotation can be presented a stall torque which fit to well it. It can be controlled through resistance. But the torque is too small in terms of theoretical calculation because of their weakness role. So if we promote the torque value it shall be controlled that current and voltage is main factor for further research. The conditions of t=6s, R₂=25Ω, U=20V result in the biggest stall force according to rotation to change time and voltage. Then it is t=8s, R₂=20Ω, U=16V; t=10s, R₂=15Ω, U=12V and t=12s, R₂=10Ω, U=8V in turns. As for torque it is t=6s, R₂=25Ω, U=20V; t=8s, R₂=10Ω, U=16V; t=10s, R₂=25Ω, U=20V and t=12s, R₂=10Ω, U=8V in turns.

REFERENCES

1. Run, X., & Zhiqing, C. (2020). Technological Analysis on Motor Stall and its Perspective. *Electrical Science & Engineering*, 2(1), 26-29.
2. Qin, Z. (2015). *Electrics*. Advanced Education Publisher, 264
3. Run, X. (2021). The Study on Simulation of Multiple Circuit Resistance in Stall Motor I. *Social Science Learning Education Journal*, 6(1).
4. Fitzgerald, A. E. (2003). *Electric Machinery*, 101.

Cite This Article: Xu Run & Zhiqiang Chen (2021). The Study on Model of Variable and Motors Resistance on Series Circuit in the Stalled DC Motor. *East African Scholars J Eng Comput Sci*, 4(6), 77-82.